

## A-80 INSTALLATION INSTRUCTIONS

1. IMPORTANT- Place furnace floor on a flat level surface. The end of floor without the angle is the stoker-hopper end. Position end of floor with small angle that is welded to the floor towards the chimney.
2. Stand furnace on the floor, centering it so that the angles on the face of furnace are inside the angles that are welded to furnace floor. Keep black face plate of furnace even with edge of floor (see page 4).
3. Install heat exchanger to furnace. Make sure that stack outlet is in the lowest position toward floor. Tighten nuts securely in an alternate diametric pattern to compress the rope seal between the flanges (see page 4). Rope seal is self- adhesive and is found in the ash tub.
4. Remove side panels from box marked sides. Using a screw driver or chisel, pry open edges in S bend on side panel (see page 3).
5. Find packet of screws inside box marked top.
6. Slide S bend of jacket panel over angle on black face plate, keeping jacket side panel inside of floor angle. Do both sides. Jacket side with hole in it is the fire door side.
7. Place the fan base in position, sliding fan base angles into slots provided on furnace sides. Keep the blower, opening in the fan base closet to the stack end. Bump down securely on each side (see page 5).
8. Install bottom bib with round hole over stack outlet, secure with 1” screws in holes provided (see page 4).
9. Slide in center partition with U channel end down and facing fan base. Then lift center partition up enough to catch U channel under fan base. Hold in this position, drill 1/8” holes through pre-punched holes in center partition into angles inside jacket. Secure with 1/2” screws (see page 5).
10. Install top bib with 1” screws in holes provided (see page 4).
11. Assemble convection blower, see blower manufacture’s instruction with blower. NOTE: Look at blower installation in furnace before assembling blower. Install convection blower over opening in blower base, secure with bolts (see page 7). NOTE: Pulley belt should be somewhat loose.

## A-80 INSTALLATION INSTRUCTIONS

12. Place a light smear of furnace cement or high temperature silicone around fire door frame. Place fire door into furnace inspection opening. Drill hole in top of door frame and bottom of door frame with 1/8" bit, secure with drill screw provided in ash tub. Put spring handle on fire door, bend hook open on spring handle and put it through predrilled hole in handle of fire door and bend it closed. Spring handle can be found in ash tub.
13. Place jacket handle on blower door in pre-drilled hole. Slide washer onto handle stem. Slide through blower door. Tap lock washer until tight against inside blower door. Tighten handle latch onto handle stem with screw. Install blower door on furnace with handle on top of door (see page 4).
14. Open box marked top. Remove jacket ring and place over stove pipe outlet, secure with attached screw (see page 4).
15. Place top of jacket onto furnace with filter rack going over heat exchanger.
16. Drill several holes with 1/8" bit along inside of top and center partition with 1" screws (see page 4).
17. Drill several 1/8" holes through furnace top and side panels, secure with 1" screws.
18. Reach inside stoker unit opening and place small hanging baffle above exhaust opening inside of furnace (see page 4).
19. Plenum chambers may now be installed.
20. Stoker units are shipped completely assembled. Lift stoker unit into opening, bottom of stoker unit has a 1/4" rod welded in place which must go inside stoker opening of furnace. Place a thick smear of furnace cement or high temperature silicone flange of stoker unit and tilt into place, securing with 3/8" x 1 1/4" machine screws, washers and nuts are provided in ash tub.
21. Place hopper on stoker unit, fasten to furnace with large metal washer and nuts. The hopper bottom should lap over stoker throat approximately 1". Since the same hopper is used with several different stokers, it may be necessary to trim the opening. Bend flange down to fit inside of throat of stoker. Be sure feed mechanism is free to operate.

## A-80 INSTALLATION INSTRUCTIONS

**INSTALLING STACK PIPE-** The heat exchanger has one (1) stack outlet used to connect stove pipe to chimney. If stack pipe must be reduced in size, **reduce stack size at thimble**. It is important to run full size stack from furnace to thimble in chimney. Install barometric draft control in first full section of stack closet to furnace. Follow instructions Packed with draft control, making sure draft control bearings are level and face of control is perpendicular to floor.

Install control harness. Secure timer and relay to furnace with, ½' screws near the top above the fire door .

Install fan limit switch in the supply plenum chamber (Page 6).

Connect 115 volt power supply to switch, black wire gets connected to open screw on switch, white wire gets wire to single white wire in switch box. Wire furnace following wiring diagram and any applicable UL, or local codes. Furnace must be on its own 20 amp circuit.

After making electrical connections, turn blower on. Be sure blower is running proper direction. To change blower direction, follow blower instructions on blower motor or install motor on opposite side of blower.

Wire stoker unit and convection blower also (see wiring diagram page 16)

Locate thermostat in an area where heat from furnace can free be reached. Mount plastic wall plate of thermostat. Connect thermostat wires to screws on lower portion of wall plate. Run thermostat wires to relay on furnace and connect wires to terminals marked T.T. (note color coding is unimportant).

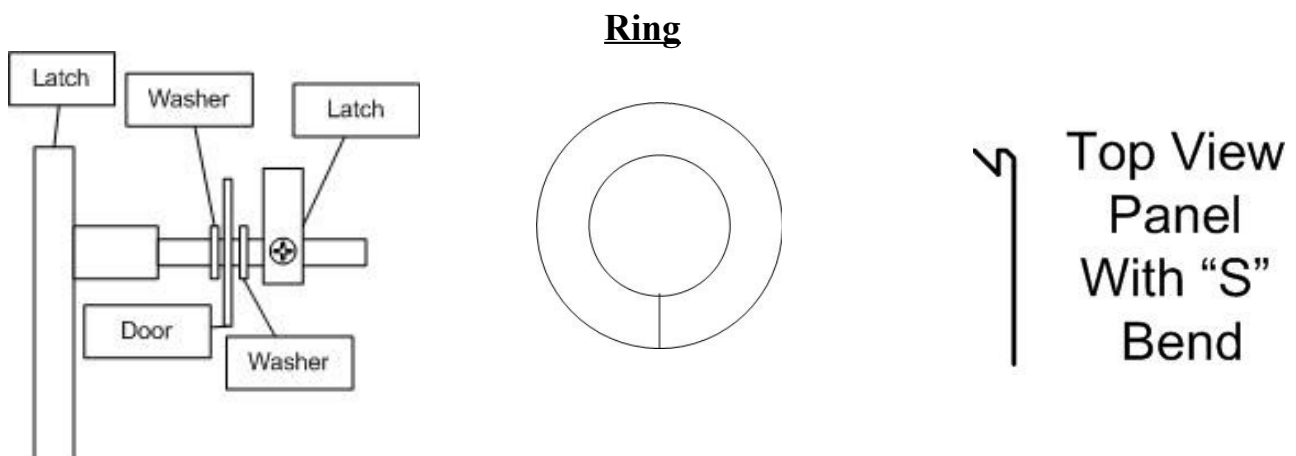

A-80 INSTALLATION INSTRUCTIONS

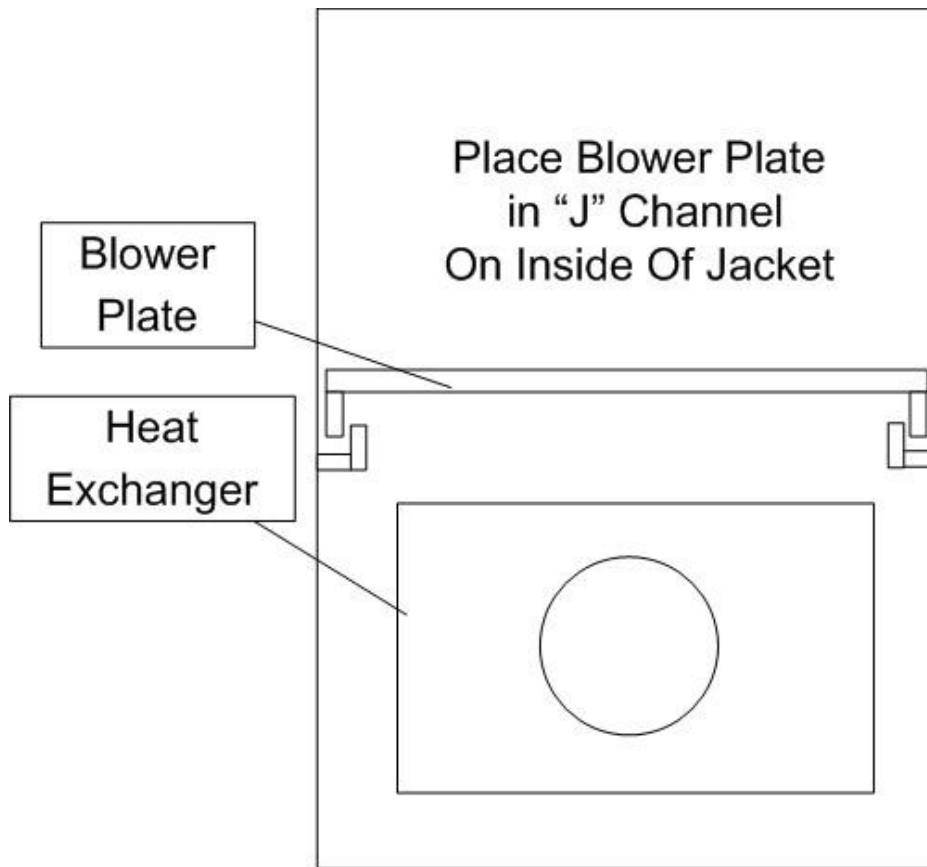
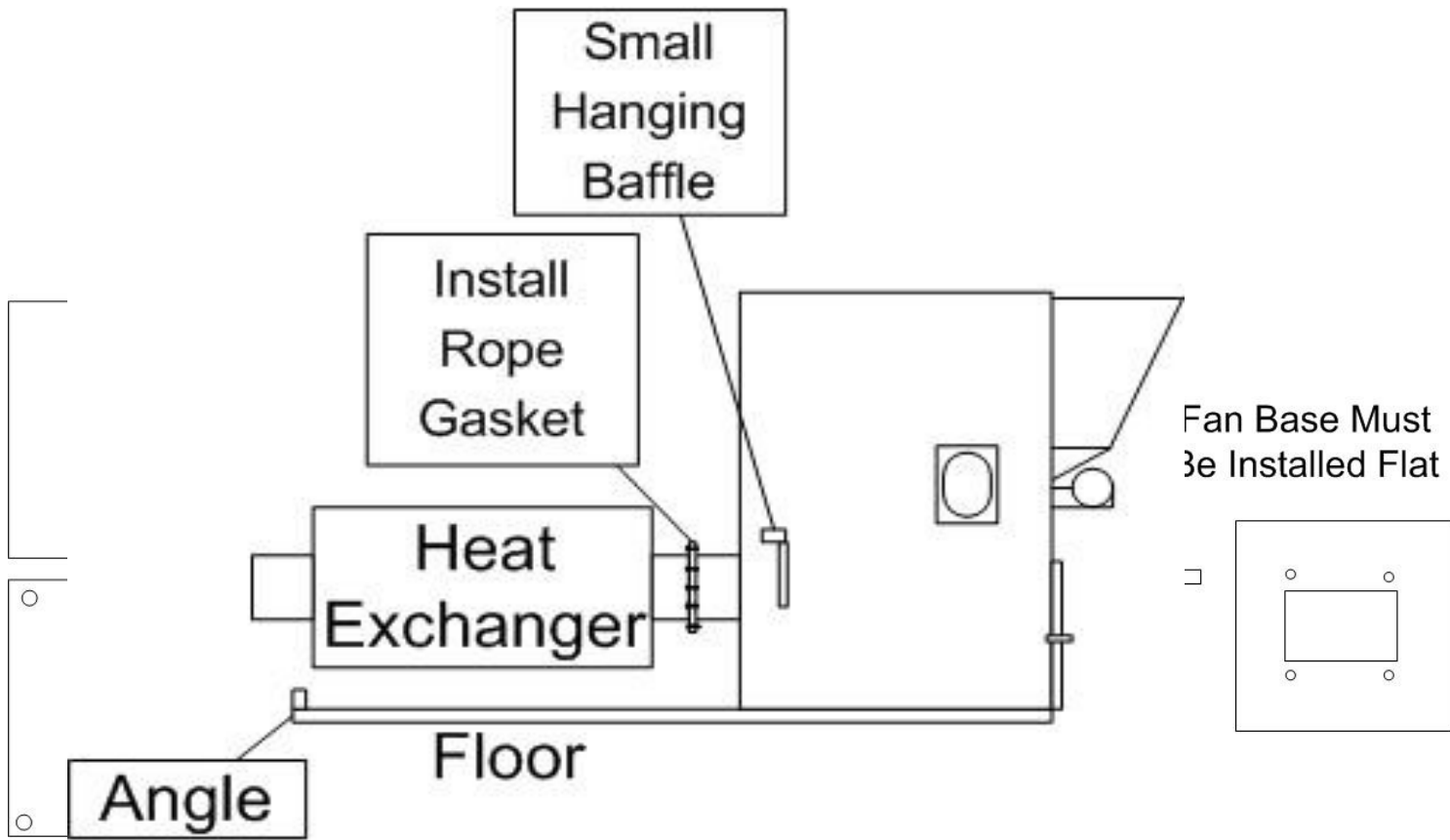

A-80 INSTALLATION INSTRUCTIONS

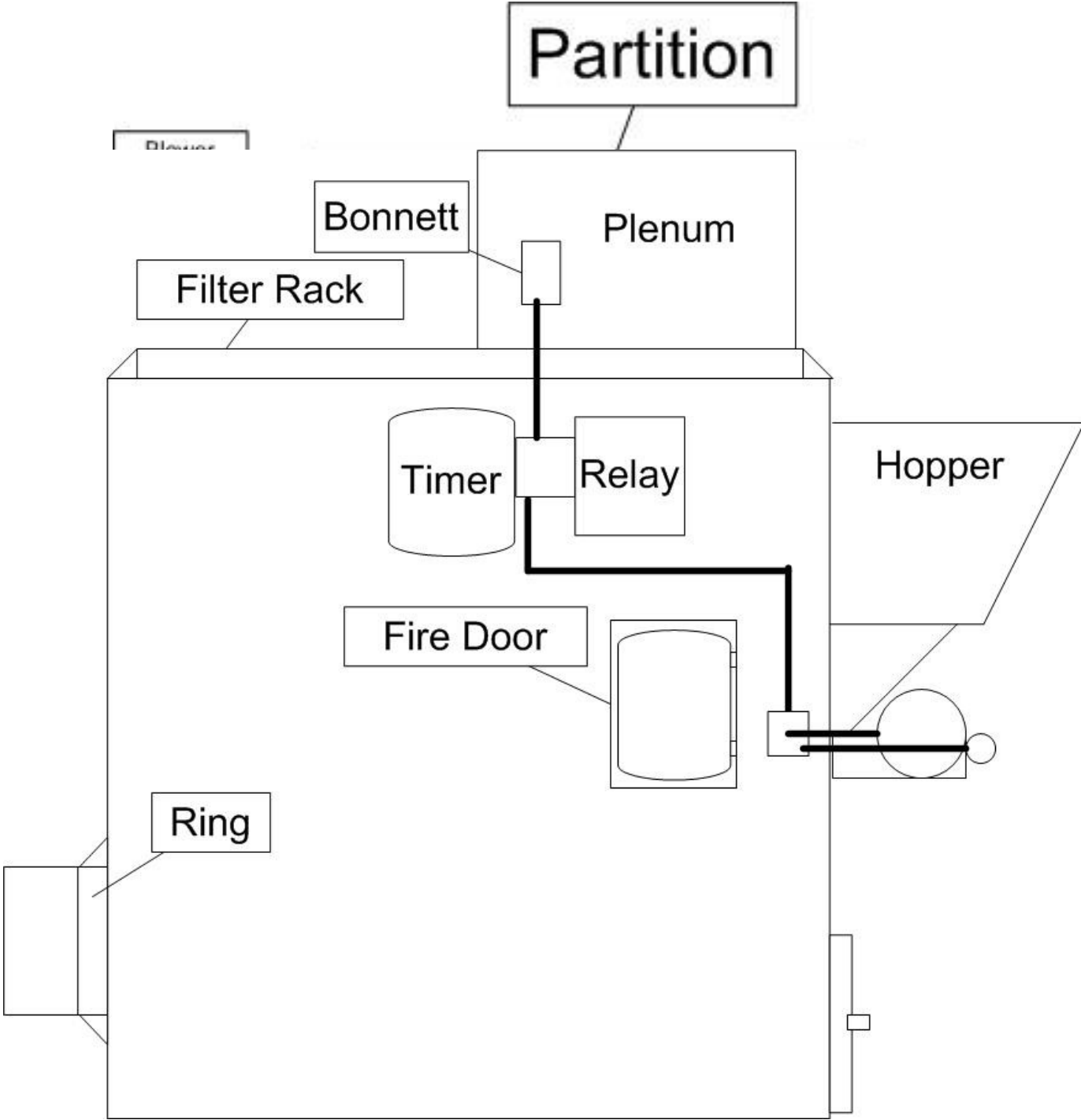

## A-80 INSTALLATION INSTRUCTIONS

1. Stoker Body
2. Side Rail Left K-2C
3. Side Rail Right K-1C
4. Grate K-15-1-L
5. Grate K-15-2-L
6. Grate K-15-3-L
7. Grate K-15-4-L
8. Motor
9. Blower Rotor
10. Bearing K-19
11. Throat Strap K-18
12. Pusher Bar Drive Yolk K-8-BC
13. Pusher Bar K-9-BC
14. Pusher bar drive shaft
15. Bearing K-17
16. Feed Crank K-7
17. Feed Assembly Connector
18. Feed Arm Nut
19. Feed Arm Adjustment Nut
20. Feed Latch K-12
21. Feed Spring
22. Feed Bolt
23. Drive Wheel K-5
24. Gearbox K-14
25. Coupling
26. Secondary Combustion Blower

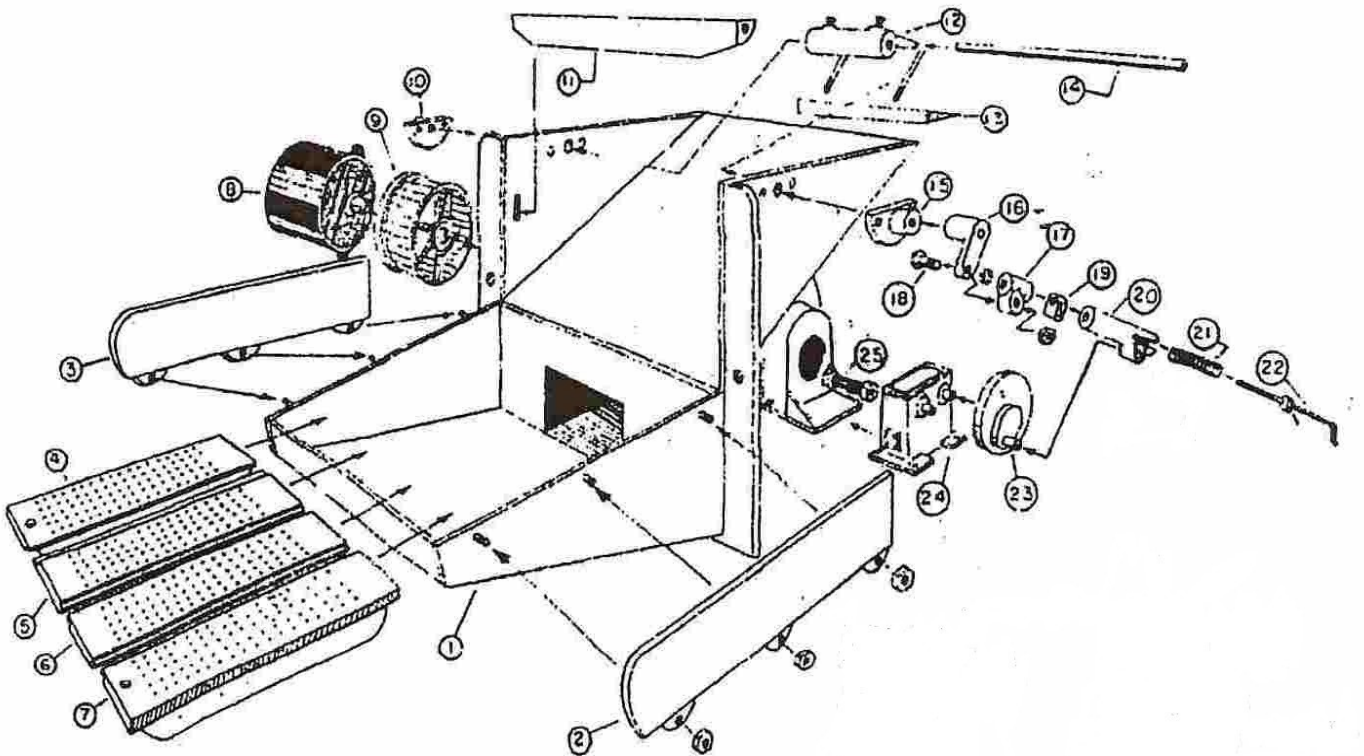

## A-80 INSTALLATION INSTRUCTIONS

### **STARTING FIRES-DO NOT USE AN ACCELLERANT SUCH AS:**

gasoline, kerosene, litter fluid, or etc. Put dry coal in hopper, pull down coal to cover entire grate. Crush several charcoal briquettes into smaller pieces, crumble newspaper and dig it through coal so that it touches the grate. Lay charcoal on top of newspaper, turn switch on, when charcoal is red, and place a few handful of coal on top of the charcoal. If fire moves toward bottom of grate before fire is established, coal feed can be slowed down by turning rd nut Counter Clock Wise (CCW) or by flipping feed bolt to a sideward position (part #22 on unit specification sheet).

After starting coal fire: Allow furnace and chimney to warm up. Insert draft gauge through pre-drilled hole in upper left portion of fire door. Open air shutter (located on the bottom of scroll between stoker motor and gear box about ½”). Then with stoker motor running and feeding coal adjust barometric damper until draft gauge reads (-.02). If draft is less than a (-.02) with the barometric damper closed you must close the air shutter (located at bottom of scroll between gear box and stoker motor. If draft is higher than (-.02) you must adjust barometric draft regulator. Move the weight on barometric damper left or right to obtain the (-.02). Recheck until you obtain a (-.20).

**SETTING TIMER-** The timer comes factory set. Yellow clock wheel makes one revolution every 30 minutes. Each clip sticking out of the yellow wheel will cause stoker to run approximately 15 seconds when clip touches switch. Timer settings will vary depending upon chimney drafts. Normal timing cycle is about one minute on and 14 minutes off (5 cycle clips side by side). Five clips at 0 and five clips at 15. If timing cycle needs to be increased, just add 1 or 2 clips to both groups of clips or if in the case of a chimney having poor draft, clips may be placed in three (3) groups at the numbers 0- 10- 20.

### **COAL FEED** (red nut):

To increase coal feed and fire size, turn red nut counter clockwise (CW).

To reduce coal feed and fire size, turn red nut counter clockwise (CCW).

Initial coal feed: Advance red nut all the way forward. Then turn it counter clockwise 11 or 12 turns if burning rice coal, if burning buckwheat coal turn coal feed, 9 Or 10 turns. When furnace is running for about an hour under full load grates should have about 2” of dead ash on them before falling into ash pan.

## A-80 INSTALLATION INSTRUCTIONS

After a fire has been established and all fresh coal that was lying on the grate has burned, it's time to set coal feed. When stoker unit is running steady (approximately 1 ½ hour), fire bed should extend downward to lower portion of the grate with approximately 2" of ash on the bottom grate. When thermostat is satisfied the stoker unit will shut off.

When stoker only runs during timing cycle, the fire bed will gradually shrink to approximately 3" to 4" or red coals. After proper length of fire bed is obtained, coal feed is set.

As prices of fuel continue to increase **KEYSTOKER**, continues to improve and make its products more fuel efficient. To obtain a more complete burn out coal, a small secondary blower motor was attached to the stoker unit. **THIS MOTOR IS DESIGNED FOR CONTINOUS RUN.**

When large stoker motor is running on demand, small blower will assist with combustion and heat output, by producing a more intense and hotter fire. When demand cycle is completed, large stoker motor will shut off, and small secondary motor will continue to run. This will cause the coal that is already on the grate to burn, rather than to allow coal to smolder and die out in an unburned condition. This will achieve a cleaner ash, and allow more heat to be produced and absorbed into heating system.

During summer operation, the small combustion motor will force a small amount of air through grates at all times, which will cause the ash to become like powder. It also prevents the fire from going out. At the same time, it reduces the size of fire bed to approximately 1 ½" to 2" which will prevent boiler water from becoming overheated.

Proper sizing of fire is obtained by turning red nut on feed control arm. Clockwise (CW) for more coal feed and Counterclockwise (CCW) for less coal feed.

Location and final placement for red nut will be determined by size of coal you purchase. For rice coal, red nut might be turned down 12 turns for maximum settings, whereas for buckwheat coal, red nut might only be turned down 10 turns from maximum setting.

During winter operation, hot coals should never be pushed off end of grate. This indicated that coal feed needs to be reduced (CCW) or if during winter operation; fire bed is too small, turn red nut (CW).



## A-80 INSTALLATION INSTRUCTIONS

After coal feed adjustment is completed, if during summer, the water is too hot.... **DO NOT ADJUST COAL FEED.** Reduce timer only. If fire goes out **DO NOT ADJUST COAL FEED.** Increase timer only.

**CLEANING** and **SERVICING**- It is most important to clean and lubricate furnace when shutting down at the end of the heating season. Corrosion of heating equipment is greatly reduced by not allowing soot to remain in furnace during the summer months.

Remove and clean stack pipe, clean base of chimney. Examine chimney for blockage with a mirror. Brush off barometric damper. Clean tubes and areas around tubes in heat exchanger, including the entrance into chamber of furnace.

Remove clean out plate (see unit specifications) from stoker unit by removing 2 screws and vacuuming out fly ash from under grates annually.

Oil stoker motor and blower motors with SAE 20 non detergent motor oil. Oil gear box with #90 Gear Oil – Oil level should be not less than ½ full, and no more than ¾ full.

Remove all coal from hopper, remove hopper, place a few drops of oil on all moving parts, joints, and bearings to prevent freeze up.

Replace Air Filters

Using a chisel or brick- scrape grates smooth. Then rub grates and inside of side rails with sand paper to remove impurities that melt and fastened themselves to grate. Make sure holes in grates are open if blocked punch open with 1/8” punch.

### **CONTROLS AND THEIR FUNCTIONS**

**Thermostat:** Top pointer is desired room temperature. Bottom pointer is thermostat. When room temperature drops below setting, combustion blower and gear motor will start. When room temperature rises, gear motor will stop (see diagram pg. 10).

**Relay:** Converts 115v to 24v for thermostat, and sends signal to gear motor to start or stop.

**Convection Blower:** Located behind enclosure on the left of stove. Blows heated air into the room. It is energized by the fan and limit control.

**Fan & Limit Control:** Serves dual purpose. 1. As a high limit, will shut off the stoker unit to prevent overheating. If internal stove temperature reaches 200

## A-80 INSTALLATION INSTRUCTIONS

degrees, control will shut off stoker unit, until temperature drops, which will then allow stoker unit to be reactivated. 2. As a convection blower control, it starts the convection blower when internal stove temperature reaches center pointer setting. The convection blower will run as long as stove remains hot. When stove begins to cool down to low setting on control, the convection blower will shut off. Normal settings for control are: High limit (pointer on right) 200 degrees. Center pointer (fan on) 160 degrees. Left pointer (fan off) 120 degrees. White button in control must be pulled out for normal automatic operation (see diagram pg. 10 & 11).

**Stoker Motor:** Function is to drive feed mechanism (pusher bar) to slide coal from hopper onto the grate, to move the fire forward and the ash into the receptacle (see diagram page 12)

**Secondary blower:** To run continuously and assist with combustion when there is a demand for heat. Helps keep furnace form over- heating and keeping fire lit when in idle mode.

**Timer:** Will activate gear motor on stoker unit, to maintain a fire during periods when no demand is made by thermostat (see diagram Below).

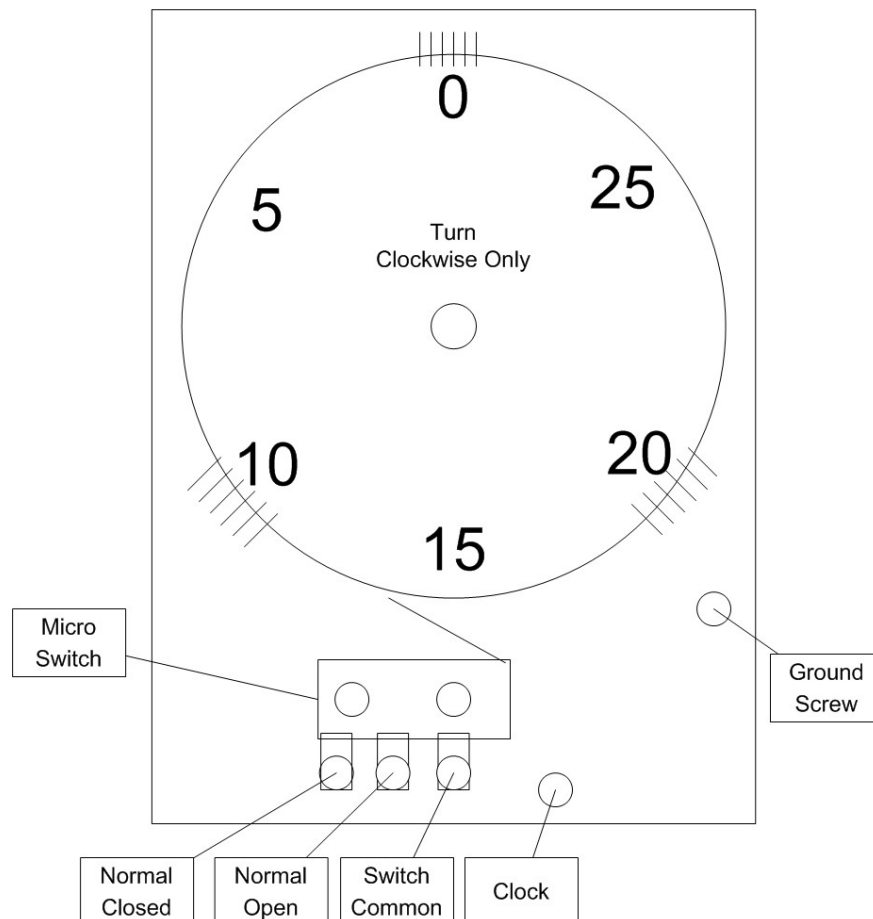

## A-80 INSTALLATION INSTRUCTIONS

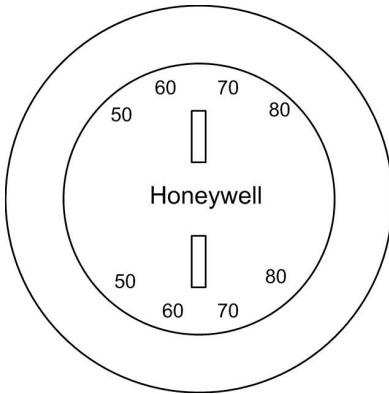

### **THERMOSTAT**

Top pointer is to be set at warmth desired in home.  
Bottom pointer is the present temperature in room. When room temperature (bottom pointer) below desired room temperature, (top pointer), this will send a signal to the Relay control to activate gear motor to push fresh coal onto grate

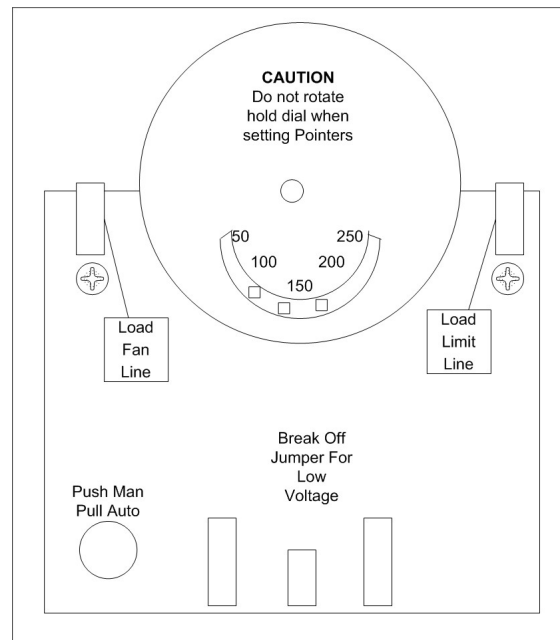

### **FAN LIMIT SWITCH**

1. **HIGH LIMIT POINTER**-is a safety switch that stops gear motor from pushing coal onto grate at 200 degrees (If stove gets too hot, this switch will turn off gear motor).
2. **CENTER POINTER**-turns convection blower on when internal air temperature reaches this setting (normally set around 160 degrees, but is adjustable).
3. **LOW POINTER**-turns convection blower off when internal air temperature falls to this setting (normally set around 120 degrees, but is adjustable).
4. Whatever number on silver dial is directly above this point is temperature of internal air.
5. **WHITE BUTTON**-pull out for automatic operation of convection blower. Push in for constant running of convection blower.

## A-80 INSTALLATION INSTRUCTIONS

**CONVECTION BLOWER**-when running, it will take cool air from room, and force it through heated air chamber inside stove, and return heated air into room. Blower can only be activated by Fan Limit Switch.

### **SAFETY**

**THE BURNING OF FOSSIL FUELS GENERATES CARBON MONOXIDE GASES. CARBON MONOXIDE GASES ARE TOXIC, CAN CAUSE SICKNESS, AND CAN BE FATAL.**

To prevent toxic carbon monoxide gases from entering the home, certain precautions must be taken.

**Ash tub** must be emptied on a regular basis to prevent ashes from overflowing into ash pit area. Excessive ash accumulation may impede air flow to the chimney, preventing gases to be drawn up chimney.

**Fire and Ash doors** must be closed at all times during normal operation.

It is necessary to keep some coal in hopper while stove is in operation.

In most applications it is sufficient to clean stove and stove pipe twice during the heating season. However, under extreme weather conditions or by high demand on stove running periods, the stove and stove pipe may need more frequent cleaning. Clean as often as necessary.

**CAUTION ASH PAN IS HOT! ALWAYS WEAR GLOVES TO REMOVE ASH PAN...**

Before removing ash pan, turn switch off or pull power cord plug from 110 volt outlet. Open ash door. Use a good pair of gloves to remove ash pan. Place ash pan on non-combustible surface. Slide an empty ash pan into stove. Close ash door. Turn switch on.

## A-80 INSTALLATION INSTRUCTIONS

PROBLEM	POSSIBLE CAUSE	REMEDY
Stoker doesn't run	Main circuit breaker tripped	Reset
	Main fuse blown	Replace
	Fuse on stoker blown	Replace
	Motor out on reset	Press rest button on motor
Stoker motor goes out on reset	Obstruction in throat of stoker	Empty hopper and clear
	Feed mechanism tight or corroded	Empty hopper and free-soaking with penetrating oil-Use dry coal to prevent reoccurrence.
	Motor or gear motor defective	Replace

### RA89 Relay

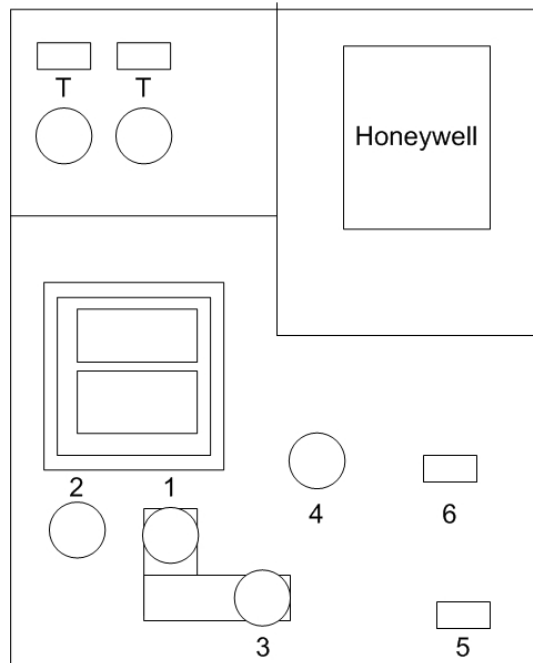

# A-80 INSTALLATION INSTRUCTIONS

## TROUBLE SHOOTING HINTS

PROBLEM	POSSIBLE CAUSE	REMEDY
Stoker runs but	Feed nut backed off	Increase feed gap proceeding

### WARM AIR WIRING DIAGRAM

WHEN WIRING IN STOKER UNIT YOU MUST RUN A 12A METTALIC WIRE DOWN TO UNIT. THE WIRES WILL HOOK UP AS FOLLOWS:  
 WHITE TO BOTH WHITES  
 BLACK TO SMALL SECONDARY BLOWER  
 RED TO BIG STOKER MOTOR

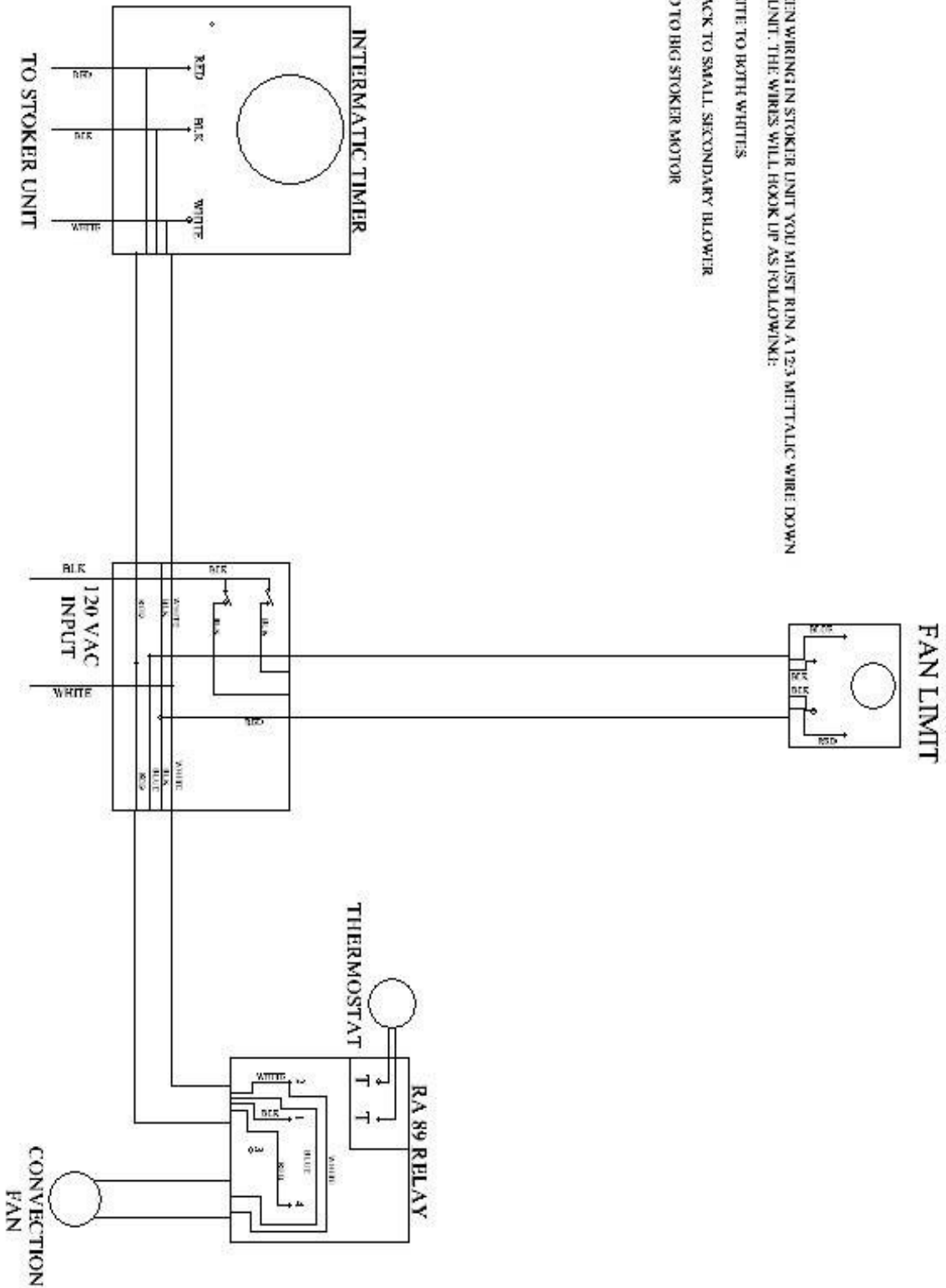

# A-80 INSTALLATION INSTRUCTIONS

**A-80 Warranty**

## A-80 INSTALLATION INSTRUCTIONS

Keystone Manufacturing Company extends the following warranties to the original owner from the date of purchase.

Five Years Workmanship on stove body

Two years on grates and side rails

One year all electric controls and motors.

Warranty does not apply if damage occurs because of improper handling, operation, abuse, rust, corrosion, misuse or use beyond rated capacity.

This warranty does not apply if the product has been altered in any way after leaving the factory.

All warranty claims should be made through dealer where the appliance was originally purchased. Model, **Stoker Unit** Number 1 ½ x 3 tag (found below hopper) and original copy of the sales receipt need be presented to dealer.

If a consumer chooses to make a warranty claim directly through Keystone Manufacturing Company model, stoker unit number, and copy of the original sales receipt are required. Customer must provide a credit card which will be charged for the full retail price for the product plus shipping and handling. When defective part is returned to the company and found to be a defect within warranty period the consumer's credit card will be credited back the cost of part.

Keystone Manufacturing Company assumes no responsibility for any labor expenses, for service, product removal, reinstallation or any freight charges for parts returned to the company.

If defective in material or workmanship and if removed by the owner with in warranty period Keystone manufacturing will at their opinion repair or replace the product.

This warranty is limited to defective parts, repair, or replacement at our opinion and excludes any incidental and consequential damages connected there with.

Warranty exclusions, labor, door gasket, ash tub, hopper and paint

### **Furnace Information**

Dealer \_\_\_\_\_

Date of purchase \_\_\_\_\_

Stoker unit number \_\_\_\_\_

Stove Model \_\_\_\_\_

### **WARM AIR CHECKLIST**



## A-80 INSTALLATION INSTRUCTIONS

_____	Thermostat	
_____	Blower Motor	
_____	A-80	1/3 Horsepower
_____	A-150	1/3 Horsepower
_____	A-250	1/2 Horsepower
_____	A-350	1 Horsepower
_____	A-450	1 1/2 Horsepower
_____	Draft Regulator	
_____	Control-Relay, Timer, and Limit Switch	
_____	Instructions	
_____	Spring Handle	
_____	(2) 3/8 Bolts	
_____	(6) 3/8 Washers	
_____	(4) Hopper Washers	
_____	(2) Drill Screws	
_____	Gaskets	
_____	Tag	
_____	(8) Metal Screws	
_____	(2) Clamps	